

FORK P128

Tomoya Tabuchi | 2016



FORK

Tomoya Tabuchi | 2016

In Japanese culture, the tree represents man who lives in harmony with nature. Rooted in the ground and open to the gifts of the heavens. Also inspired by this superior balance, with its perfectly corresponding ideas, the FORK table pays homage to a combination of skilled Italian craftsmanship and Japanese minimalism. Thanks to its legs with an aluminium coupling and modular parts in various materials, the FORK table is part of a system, available in a vast range of shapes and heights, ideal for the office and the home. This is achieved when finding inspiration in nature.



FORK

Tomoya Tabuchi | 2016

P128 with wood or Fenix top 200 ÷ 240 H74

Base composed of aluminium drawn tube with elliptical section and a 4-way connection in die-cast recycled aluminium powder coated with a fixing plate for the top. Legs in aluminium extrusion veneered in wood or powder coated in several finishes. Adjustable knurled glides in nylon. Tops with beveled edge in plywood of birch veneered in oak or in MDF if lacquered or in hpl Fenix®. Edges are lacquered in the same colour of the top.

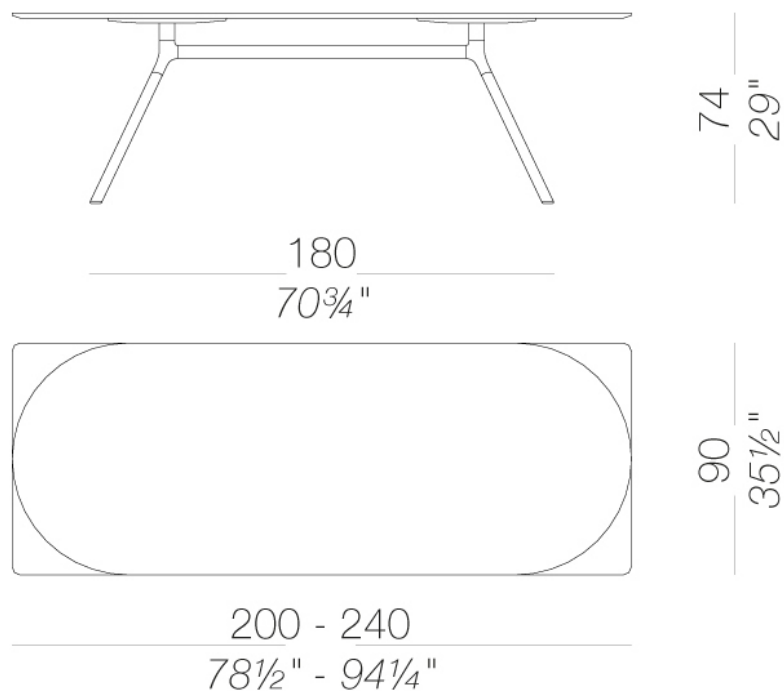

FORK P128

Tomoya Tabuchi | 2016

frame



powder coating
black
1 Colors

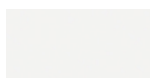

powder coating
white
1 Colors

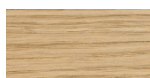

wood
blached oak
1 Colors

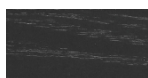

wood
black open pore
1 Colors

top



laminate
fenix 9/10
2 Colors

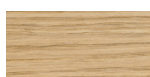

wood
blached oak
1 Colors

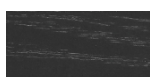

wood
black open pore
1 Colors

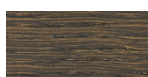

wood
oak dark walnut
1 Colors

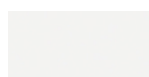

lacquered
white lacquered
1 Colors

consult the portfolio for the range of colors, fabrics, eco-leather, soft-leather.

use and maintenance instructions

Clean all parts in wood, leather, fabric and metal with a damp cloth or a diluted neutral cleaner. Do not use cleaners with alcohol, bleach, solvent or abrasive products. Any liquid spilt on the product must be wiped up immediately. When lifting or moving the product, hold it on the structure and not under the seat. The product should not be subjected to unbalanced weights, as it is designed for a proper rest on the foothold (on four legs or on the base). Our company relieves from any responsibility in case of damage caused to fragile floors. Avoid any improper use of the product: do not step on the product, on the footrest or on the armrests. Avoid any movements that could compromise the proper functionality of the product or the safety of the users. Wood and leather, being natural materials, could be easily damaged. Small impurities or imperfections are within quality standard range. Do not expose the product to weather conditions or atmospheric agents, nor to heat sources over 40°C. Also products for outdoor use could be afflicted by atmospheric agents. The product could undergo possible exterior changes due to particular exposure to heat, humidity and saltiness. An appropriate and frequent maintenance and cleaning of the product enhances its durability. The product could change colour and shade, if exposed to direct sunlight. Maintenance has to be carried out by experienced staff. Dispose of the package only after assembling the product, in order to avoid the loss of ironmongery and components. Once the product has been dismantled, the product itself or its components must be given to the public garbage disposal system, according to the legislation in force.