

# MAK

Patrick Norguet | 2012



# MAK

Patrick Norguet | 2012

As vibrant as the occasions it accompanies, MAK is a stool with an elegant line, a contrast of circles and curved lines that perfectly balance the column, the seat and footrest. Its character is informal and light-hearted.



# MAK

Patrick Norguet | 2012

## | S110 swivel and height-adjustable upholstered stool H55 ÷ 80

Stool with metal frame powder coated and height adjustable swivel seat in MDF upholstered with fire retardant polyurethane moulded foam and covered with fabric, soft leather or eco-leather. Felt under the base.

TEST EN 1728:2012 6.21 - EN 16139:2013 - L2 extreme

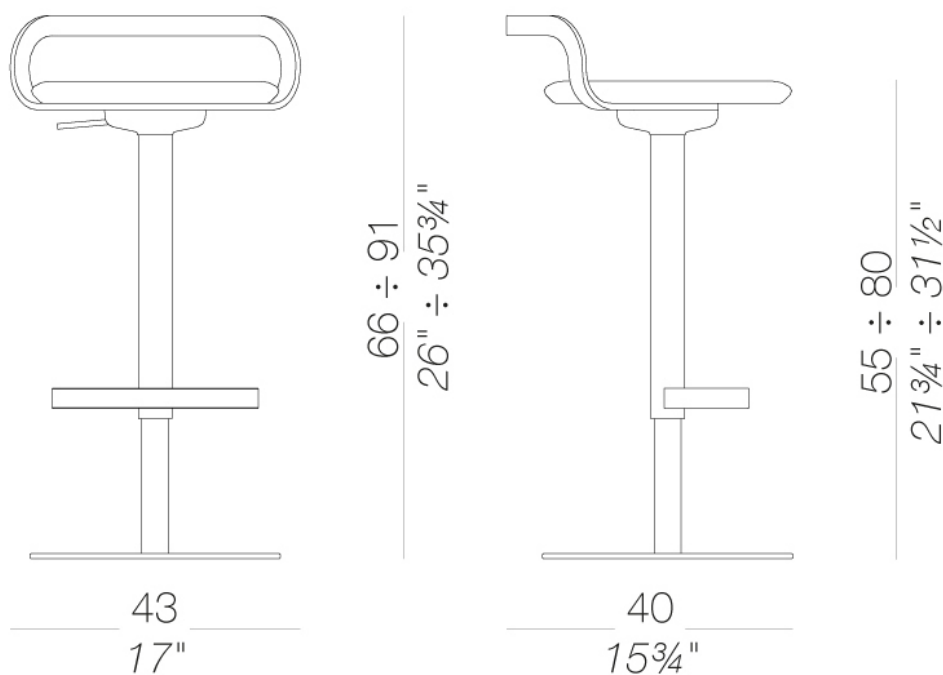

# MAK

Patrick Norguet | 2012

## frame



powder coating  
pistacchio  
1 Colors



powder coating  
black  
1 Colors



powder coating  
white  
1 Colors



powder coating  
perla  
1 Colors



powder coating  
celeste  
1 Colors



powder coating  
mattone  
1 Colors



powder coating  
oliva  
1 Colors



powder coating  
tortora  
1 Colors

## seat



fabric  
Hallingdal 65 - Grade  
C  
58 Colors



fabric  
Canvas 2 - Grade C  
45 Colors



fabric  
Steelcut Trio 3 -  
Grade D  
54 Colors

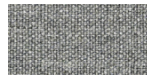

fabric  
Remix 3 - Grade C  
72 Colors



fabric  
Fiord 2 - Grade C  
39 Colors



fabric  
Divina MD - Grade D  
27 Colors



fabric  
Divina Melange 3 -  
Grade D  
38 Colors



fabric  
Tonica 2 - Grade C  
39 Colors

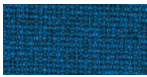

fabric  
Medley - Grade A  
37 Colors

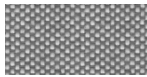

fabric  
Maya - Grade A  
43 Colors



fabric  
Jet - Grade A  
66 Colors

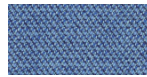

fabric  
Capture - Grade B  
60 Colors



fabric  
Crisp - Grade B  
40 Colors



fabric  
Iris - Grade B  
34 Colors



fabric  
Steelcut 3 - Grade D  
40 Colors

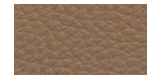

soft-leather  
Soft-leather  
17 Colors



ecoleather  
Valencia - Grade B  
72 Colors



fabric  
Grain - Grade. B  
50 Colors



fabric  
Re-wool - Grade C  
24 Colors



fabric  
Main Line Flax -  
Grade. B  
57 Colors



fabric  
Blazer - Grade. C  
77 Colors

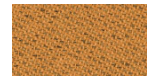

fabric  
Chili - Grade. A  
47 Colors



fabric  
Umber - Grade. B  
36 Colors



fabric  
Nobel - Grade. C  
30 Colors



fabric  
Naveli - Grade. C  
24 Colors

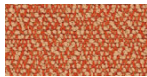

fabric  
Fiocco - Grade. B  
34 Colors

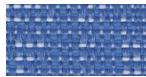

fabric  
Atrium - Grade. C  
16 Colors



fabric  
Panama - Grade. A  
48 Colors



fabric  
Sorrento - Grade. B  
22 Colors

**consult the portfolio for the range of colors, fabrics, eco-leather, soft-leather.**

**use and maintenance instructions**

Clean all parts in wood, leather, fabric and metal with a damp cloth or a diluted neutral cleaner. Do not use cleaners with alcohol, bleach, solvent or abrasive products. Any liquid spilt on the product must be wiped up immediately. When lifting or moving the product, hold it on the structure and not under the seat. The product should not be subjected to unbalanced weights, as it is designed for a proper rest on the foothold (on four legs or on the base). Our company relieves from any responsibility in case of damage caused to fragile floors. Avoid any improper use of the product: do not step on the product, on the footrest or on the armrests. Avoid any movements that could compromise the proper functionality of the product or the safety of the users. Wood and leather, being natural materials, could be easily damaged. Small impurities or imperfections are within quality standard range. Do not expose the product to weather conditions or atmospheric agents, nor to heat sources over 40°C. Also products for outdoor use could be afflicted by atmospheric agents. The product could undergo possible exterior changes due to particular exposure to heat, humidity and saltiness. An appropriate and frequent maintenance and cleaning of the product enhances its durability. The product could change colour and shade, if exposed to direct sunlight. Maintenance has to be carried out by experienced staff. Dispose of the package only after assembling the product, in order to avoid the loss of ironmongery and components. Once the product has been dismantled, the product itself or its components must be given to the public garbage disposal system, according to the legislation in force.